

Flat Panel VMT

Installation Manual

EN

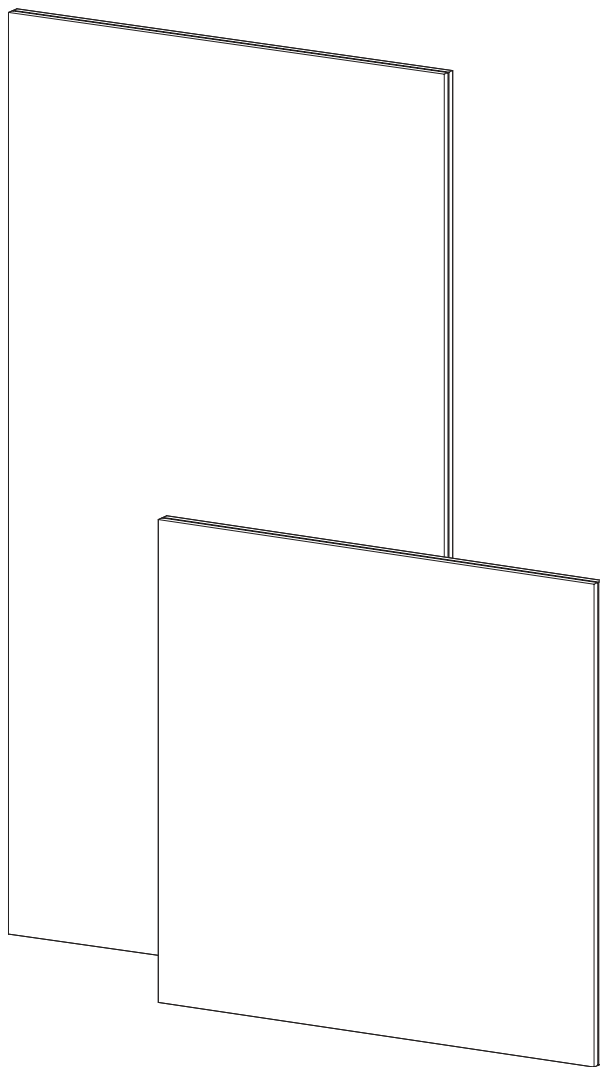

V/COUSTIC

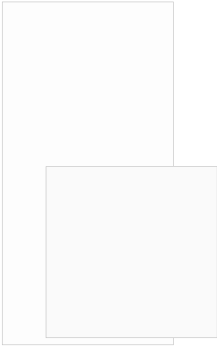
MATERIAL NEEDED**Included**

Flat Panel VMT x8



Velcro Stripes x16

Not Included

Level



Measuring Tape

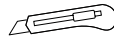

Box Cutter

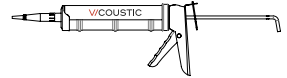

Flexi Glue Ultra

Available formats

1190x595mm



595x595mm

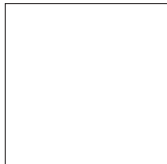

Partial wall installation

You can also use this method to install this product on the ceiling.

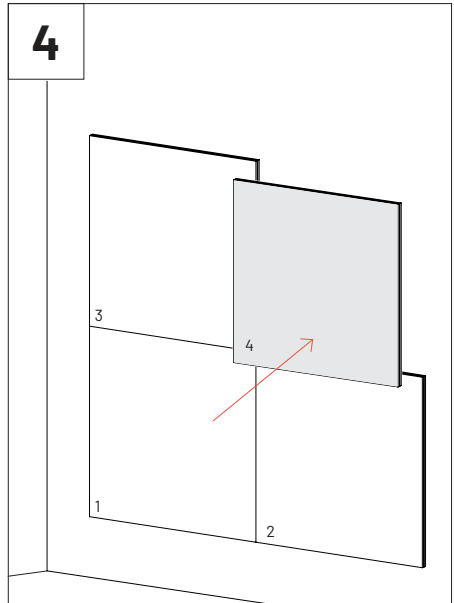
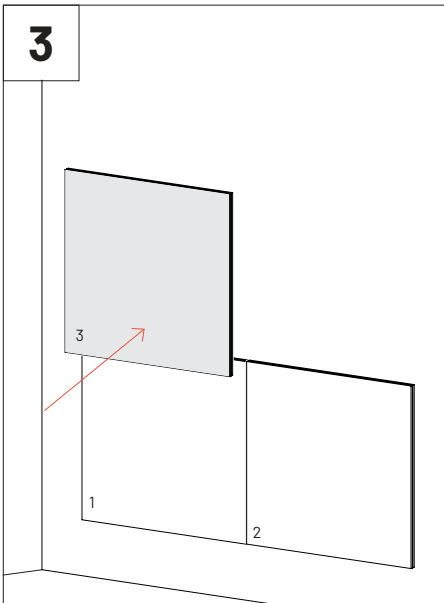
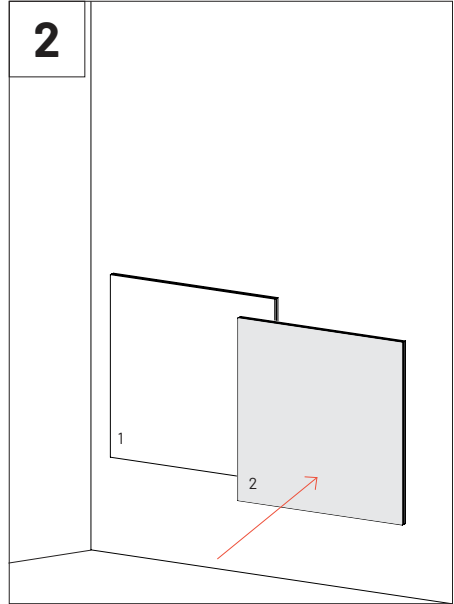
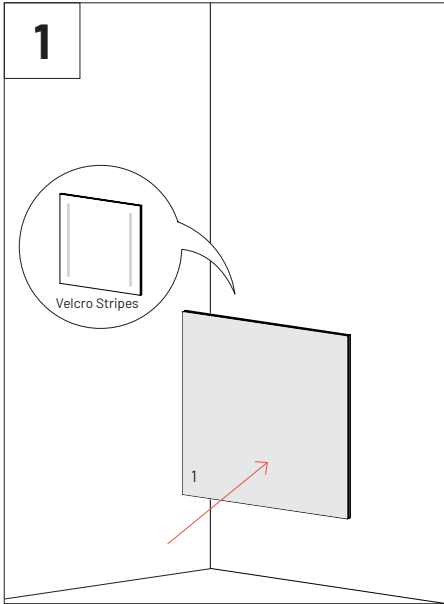

Full wall installation

*You can also use this method to install this product on the ceiling.

1

Measure wall height in both sides. Take the smallest height.

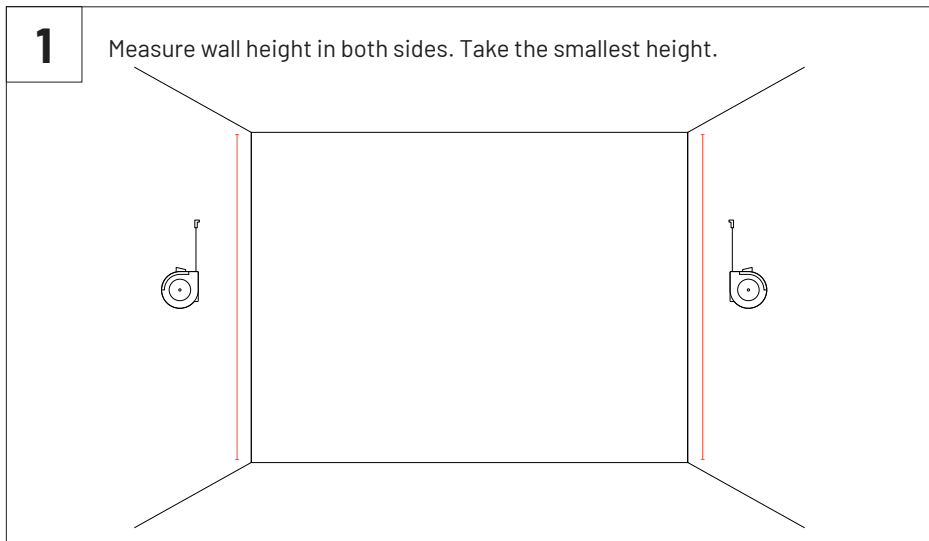
**2**

Based on the smallest height, calculate if it is necessary to cut one of the panels to fill the entire wall height. Check for continuity between panels before cutting.

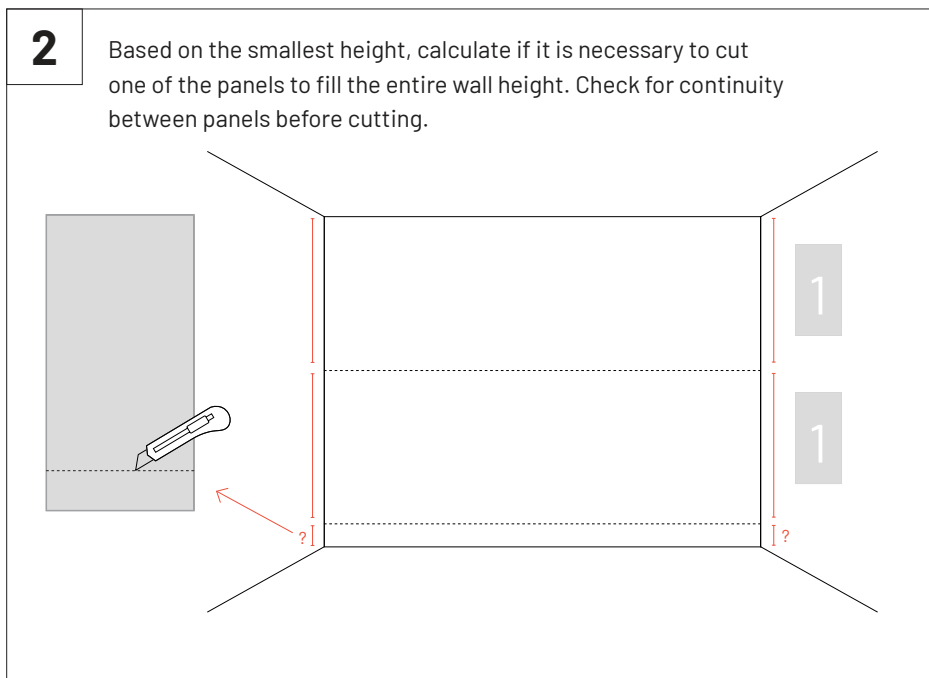

3

Glue the Velcro tape in the wall. It is recommended to use 2 stripes of Velcro per panel (included). You can also glue the panels directly to the wall with Flexi Glue Ultra

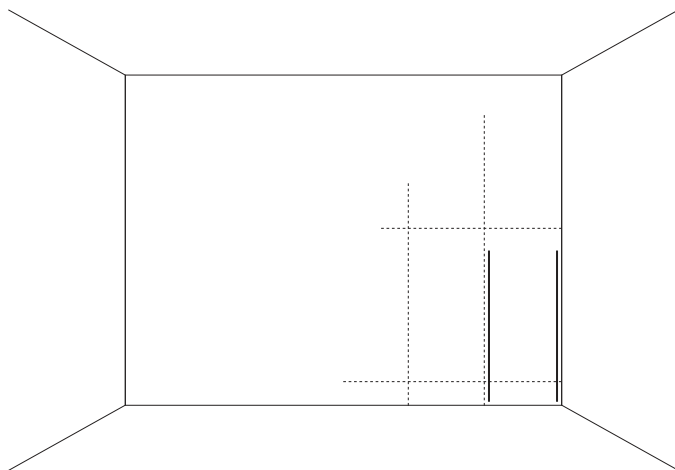

4

Start the installation from the bottom-right side (If cuted panels are going to be used it is recommended to start with these). Check if panels are leveled before proceeding to next row.

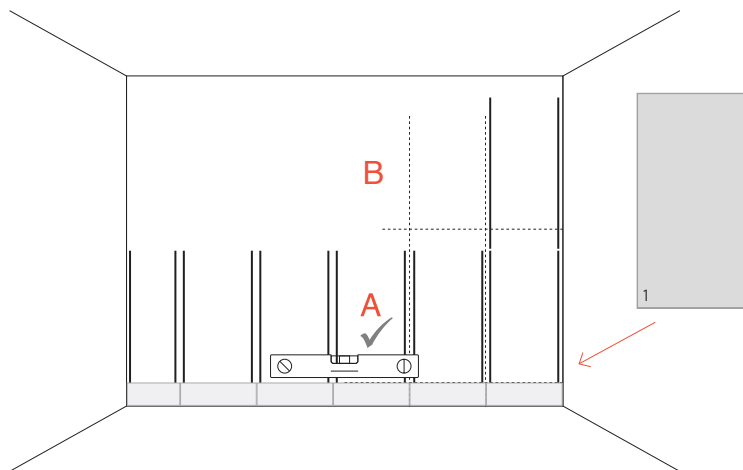

5

Install the remaining panels.

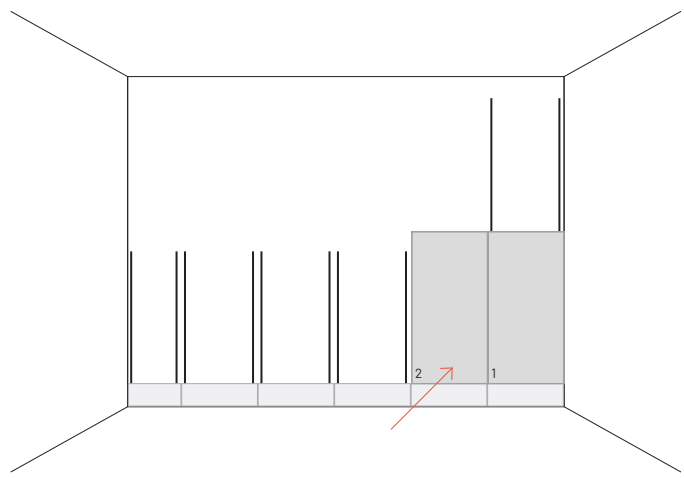

6

VMT boards can be installed vertically or horizontally, depending on the pattern and desired orientation.

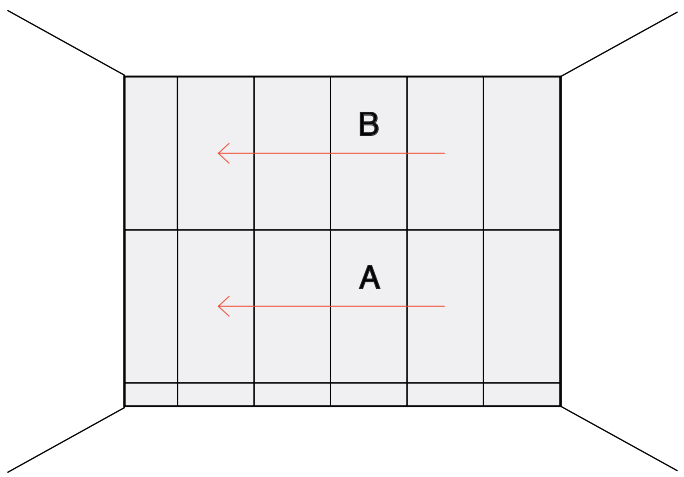

Main Office, R&D & Logistics

Avenida do Pólo 3, N.º 159, Carvalhosa
4590-137 Paços de Ferreira, Portugal
T (+351) 255 136 746

Office

Rua Quinta do Bom Retiro N.º 16, Armazém 9
2820-690 Charneca da Caparica, Portugal
T (+351) 212 964 100

Info and Sales

E sales@vicoustic.com

www.vicoustic.com



© Vicoustic, 2019 | V3

No parts of this document might be copied and/or published without written consent of Vicoustic.